

# TIROIR+SERRURE

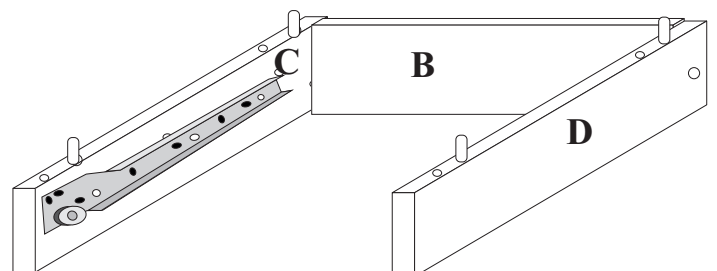

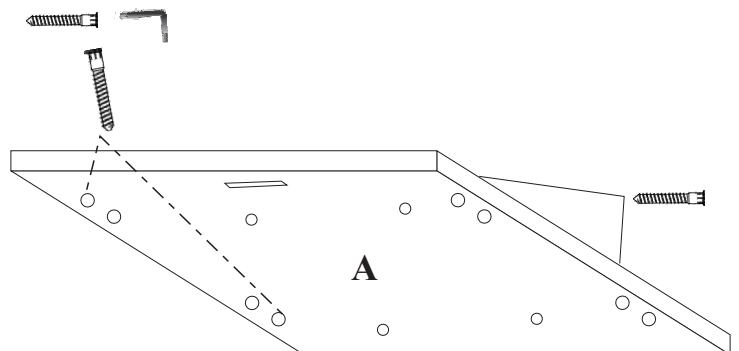

**Panneau de contre épaisseur**  
à utiliser pour le montage du bloc tiroir  
sous les plateaux de la Banque d'accueil  
ou la Banque Informatique

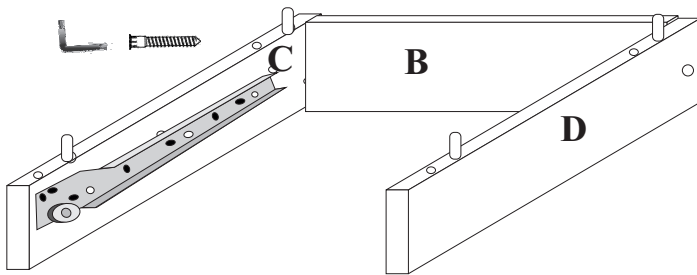
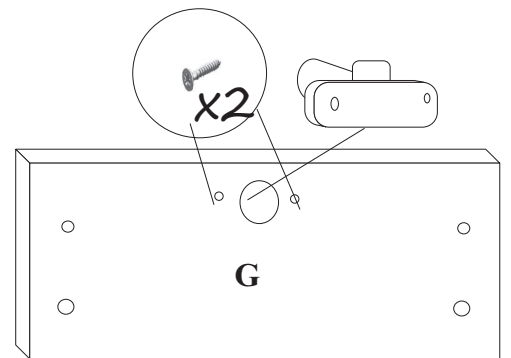
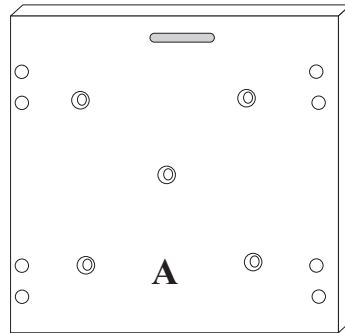
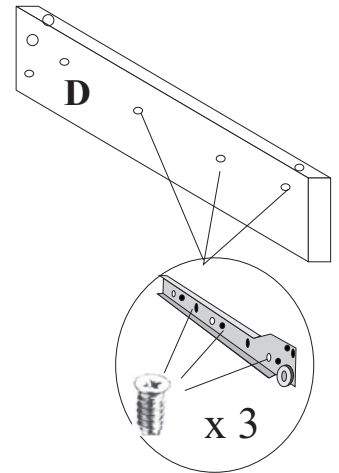
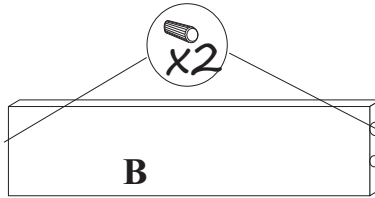
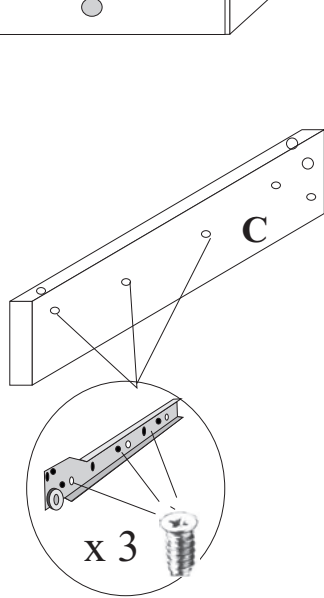
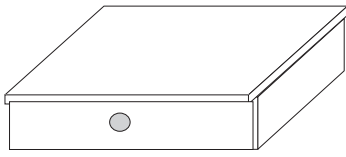
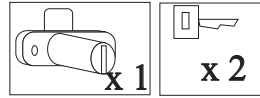
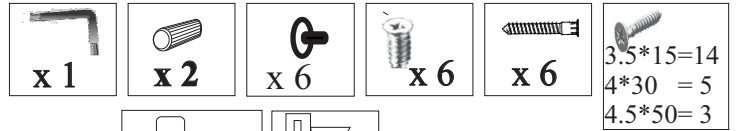
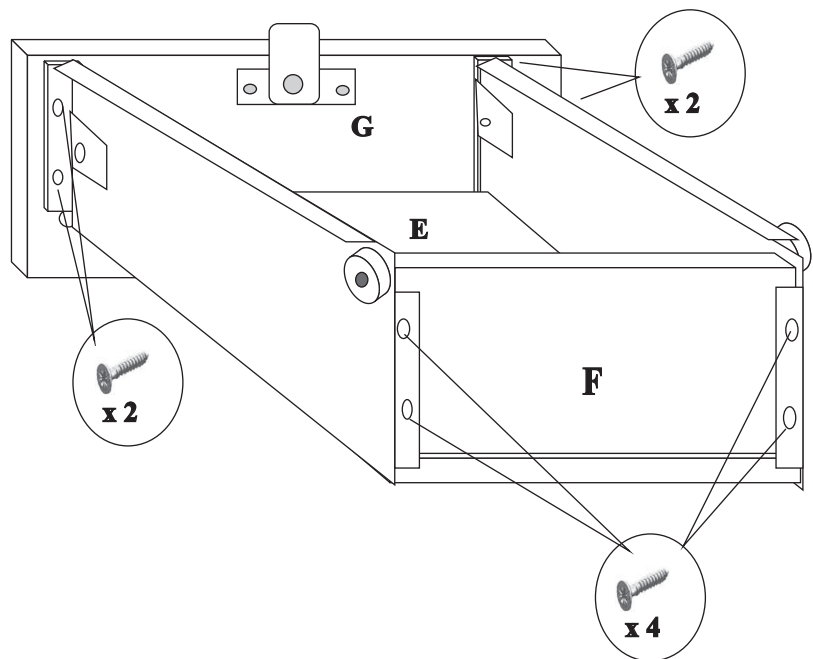
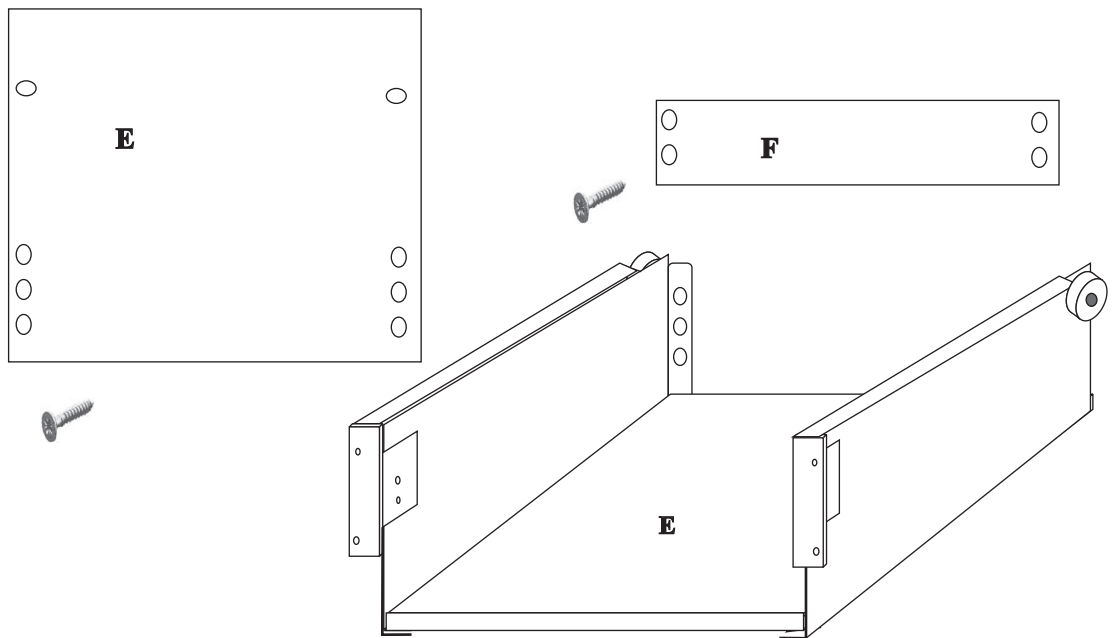
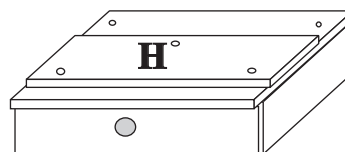

**Pour la fixation sous plateau de la Banque d'accueil  
ou la Banque Informatique**  
Utiliser 3 Vis Longueur 50 mm sur l'avant  
et 2 vis Longueur 30 sur l'arrière